

# Flat Cable Saddles, Self Adhesive, Locking Latch

Material	<b>Nylon 66 (UL)</b>
Flame class	<b>94V-2</b>
Color	<b>Natural</b>
Unit	<b>mm</b>

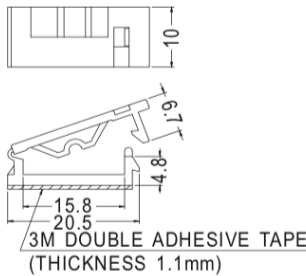

Part No	Package
2805 0102	500



Part No	Package
2805 0117	200

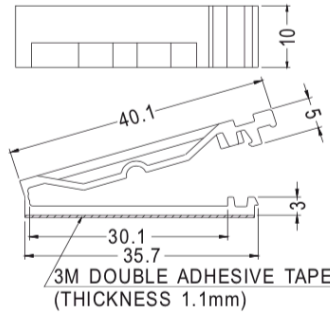

Part No	A	B	C	D	Package
2805 0132	19.7	77.6	64.0	12.8	50
2805 0133	19.0	53.5	40.0	11.2	100
2805 0134	19.0	45.8	32.0	11.2	200
2805 0135	19.8	45.4	31.8	18.0	200
2805 0136	19.3	53.5	39.7	14.8	
2805 0137	19.3	53.5	39.7	14.5	200

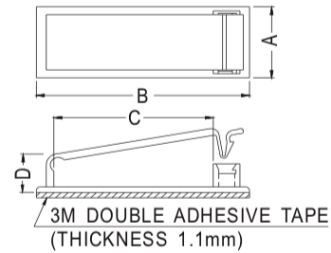

Part No	Package
2805 0152	200

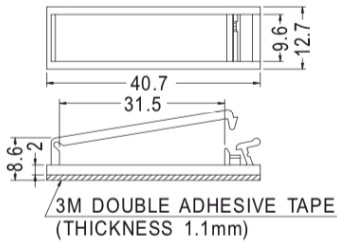

Part No	A	B	C	Suitable cable	Package
2805 0236	53.8	65.0	10.2	40 PIN	200
2805 0237	64.5	77.0	10.0	50 PIN	100

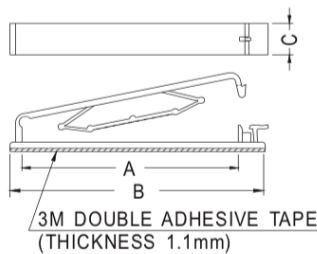

Part No	A	B	C	Package
28082356	9.6	12.7	13.2	200
28082357	12.0	15.0	15.9	200

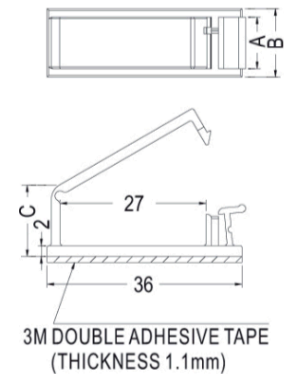

# Flat Cable Saddles, Self Adhesive, Locking Latch

Part No	Package
2805 0252	100

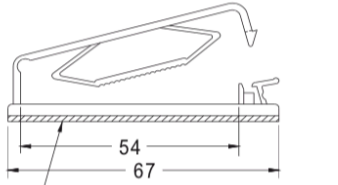

3M DOUBLE ADHESIVE TAPE  
(THICKNESS 1.1mm)  
SUITABLE CABLE: 40 PIN

Part No	Package
2805 0267	100

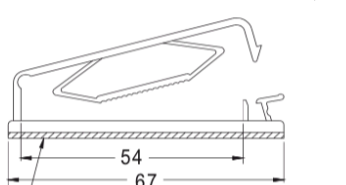

3M DOUBLE ADHESIVE TAPE  
(THICKNESS 1.1mm)  
SUITABLE CABLE: 40 PIN

Part No	Package
2805 0282	200

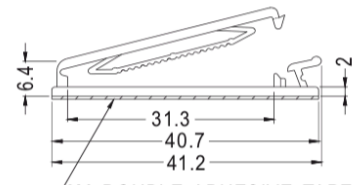

3M DOUBLE ADHESIVE TAPE  
(THICKNESS 1.1mm)

Part No	Package
2805 0327	100

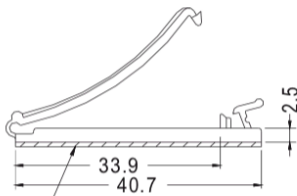

3M DOUBLE ADHESIVE TAPE  
(THICKNESS 1.1mm)

Part No	A	B	C	D	Package
2805 0317	31.5	40.7	2.0	6.8	50
2805 0318	19.0	61.2	2.1	6.9	100

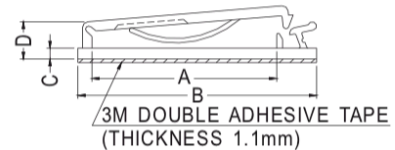

3M DOUBLE ADHESIVE TAPE  
(THICKNESS 1.1mm)